



Company Profile:

Sunkye International Co., Limited.(Connector) Business Group, with sixty five years of experience, specializes in designing and producing connectors, related components and cables. A wide range of connector products, twist pin connector, optical fiber connector, RF coaxial connector, separable connector, custom and application-

Company profile

specific connector, etc, which are widely used in military area: aerospace, aviation, electrical, ship-building, defense system, etc and civil area: communication, telecom, automotive, rail, etc.

Design team focuses on meeting customers' requirement with continuous innovative technology, manufacture team provides high quality products by utilizing advanced equipments in standardized processes to ensure customers' benefits.

Sunkye is ISO 9001 certified, UL, VDE, CE certification passed, and ensures products quality by testing in realistic conditions with advanced test facilities, professional test employees.

Sunkye team is committed to offering high quality products, best service, prompt delivery and competitive price for you.



Manufacture Equipment:

Five-Axis CNC, AGIE EDM, SODICK WEDM-LS, 40G Vector Network Analyzers, Vacuum Heat Treatment Equipment, Glass-sintered System, Laser Processing Center, High Velocity Ram Machine, Gold, Nickel and Cadmium Plating Production Line, Thermosetting Injection Machine, Thermoplastic Injection Machine, Swiss Automatic Lathe, etc.

Test Facilities:

Comprehensive Test Instrument of Temperature, Humidity and Vibration; Experimental Box of Temperature and Shock; layer thickness meter; Coordinate Measurement Machine, etc.



MIL-DTL-83513 Micro-D Connectors

SUNHYE



CONTENT



MIL-DTL-83513 Micro-D Connectors

R04A Series Straight to PCB Connectors

MIL-DTL-83513 Micro-D Connectors R04A Series Straight To PCB Connectors



Brief Introduction

- Micro-D Connectors
- Twist Pin Contacts, High Density
- Metal Shell, Nickel or Cadmium Plating
- Straight to PCB Connectors
- Meets MIL-DTL-83513

Specifications

■ Environment Temperature :	-55°C~+125°C
■ Vibration:	10Hz~2000Hz, 196m/s ²
■ Random Vibration:	Power spectrum density 0.4G ² /Hz, root mean square value of total acceleration 23.1G
■ Shock:	735m/s ² , 11sm
■ Rated Current:	3A
■ Contact Resistance:	10mΩ
■ Insulation Resistance:	5000MΩ
■ Dielectric Strength:	800V
■ Durability:	500 times

Product Stereogram



SA Style



SB Style

Contact Arrangements

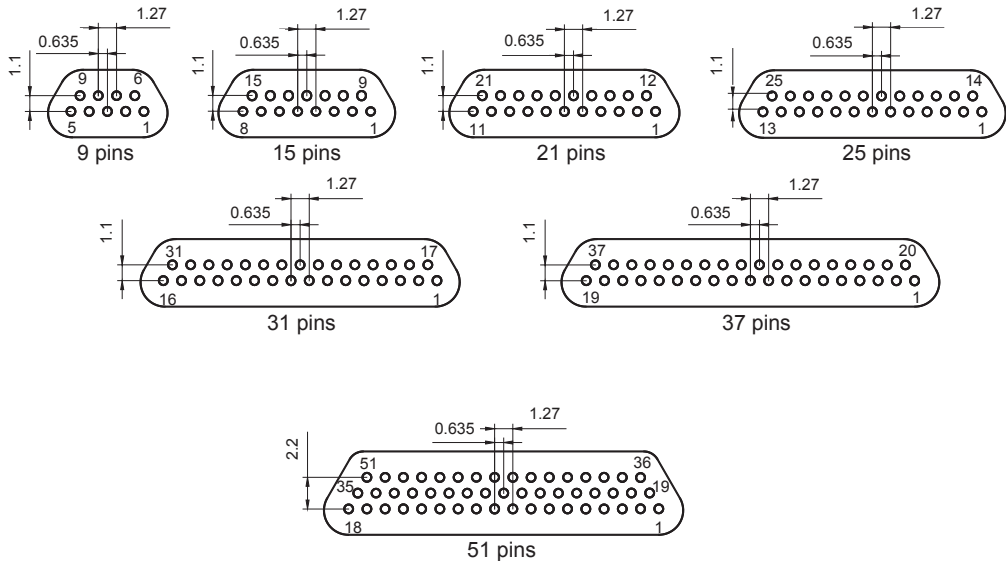

Mating Face of Male Connectors

How To Order

Sample Part Number	R04A	-31	PI	SA	3	N04	G
Series: R04A—Micro-D Connectors for MIL-DTL-83513							
Contact Number: 9, 15, 21, 25, 31, 37, 51pins							
Contact Type: PI—Pin in Plug RH—Socket in Receptacle							
Termination Type: SA Style and The PCB Layout is 2.54*1.91mm SB Style and The PCB Layout is 2.54*2.54mm							
Tail Length: 1—2.77mm 2—3.56mm 3—4.37mm							
Locking Hardware: N04—Locking Hardware Type (See page 3)	No Code—No Locking Hardware						
Shell Material and Finish :: G—Aluminum Shell, Cadmium Plating	No Code—Aluminum Shell, Nickel Plating						

Locking Hardware

Code	Feature	Stereogram	Outline Dimensions
N04	<ol style="list-style-type: none"> 1. Jackpost 2. Hex Head 3. Vertical Mounting with PCB 		

Remark: All dimensions are in mm.

Tail Lengths

Tail Code	Tail Length	Recommend The Thickness Of PCB
1	2.77	1.2~2.2
2	3.56	2.0~3.0
3	4.37	2.8~3.8

Remark: All dimensions are in mm.

R04A Series Straight To PCB Connectors-SA Style

Product Stereogram



Outline Dimensions

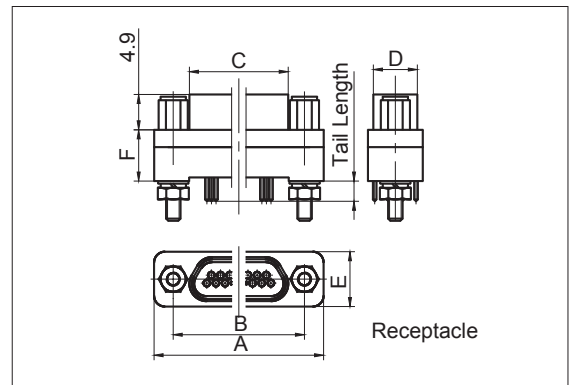
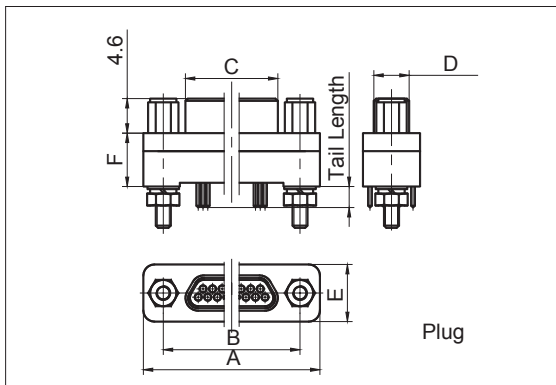

Part Number	Outline Dimensions					
	A	B	C	D	E	F
R04A-9PISA	19.6	14.3	8.4	4.7	7.6	7.1
R04A-15PISA	23.8	18.2	12.3	4.7	7.6	7.1
R04A-21PISA	27.3	22	16.1	4.7	7.6	7.1
R04A-25PISA	29.8	24.5	18.6	4.7	7.6	7.1
R04A-31PISA	33.6	28.3	22.4	4.7	7.6	7.1
R04A-37PISA	37.4	32.1	26.2	4.7	7.6	7.1
R04A-51PISA	36.5	30.9	25	5.8	8.7	8.2
R04A-9RHS	19.6	14.3	9.9	6.1	7.6	7.1
R04A-15RHS	23.5	18.2	13.7	6.1	7.6	7.1
R04A-21RHS	27.3	22	17.5	6.1	7.6	7.1
R04A-25RHS	29.8	24.5	20.1	6.1	7.6	7.1
R04A-31RHS	33.6	28.3	23.9	6.1	7.6	7.1
R04A-37RHS	37.4	32.1	27.7	6.1	7.6	7.1
R04A-51RHS	36.5	30.9	26.7	7.2	8.7	8.2

Remark: All dimensions are in mm.

R04A Series Straight to PCB Connectors SA Style-PCB Layout

Plug Connectors

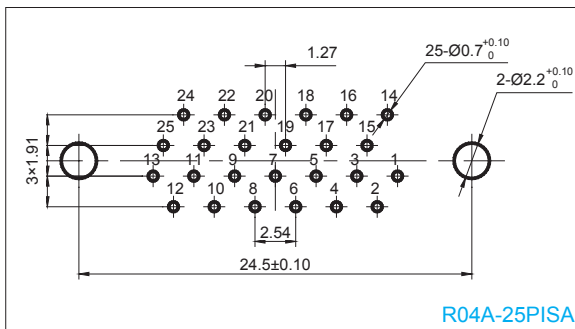
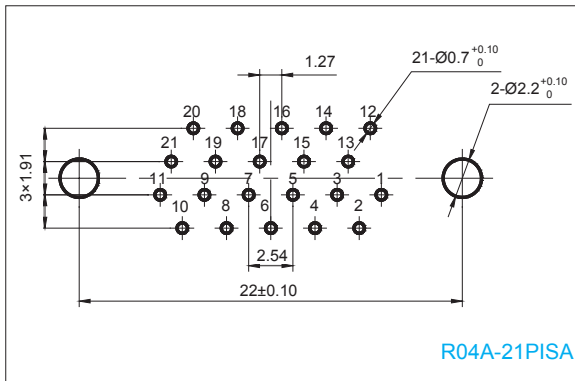
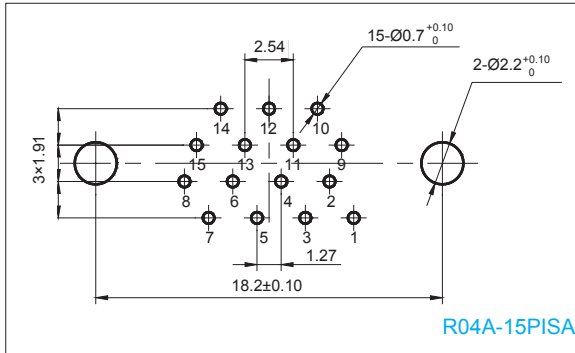
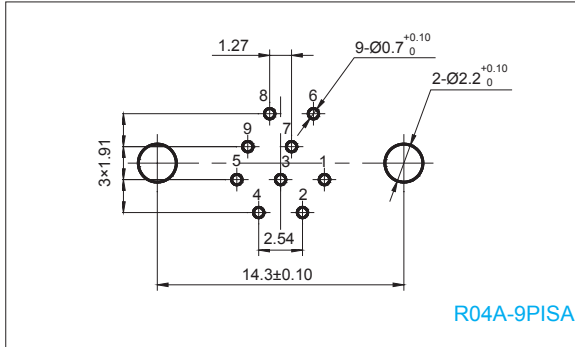

Receptacle Connectors

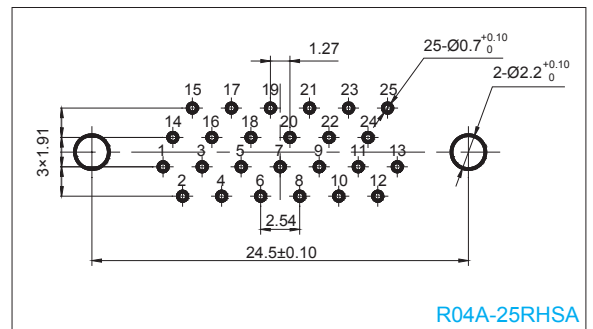
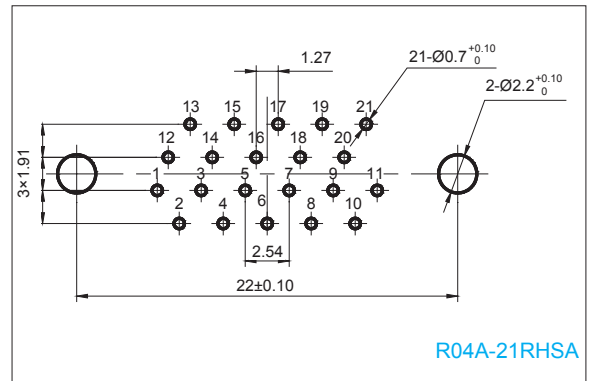
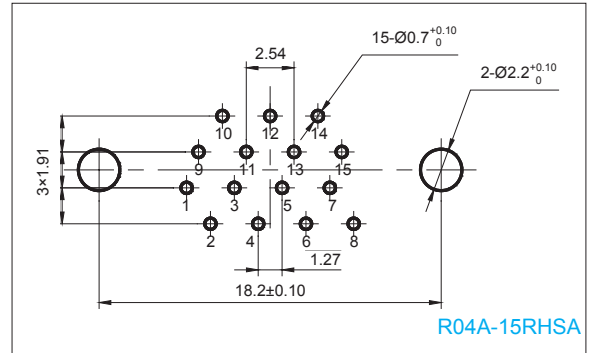
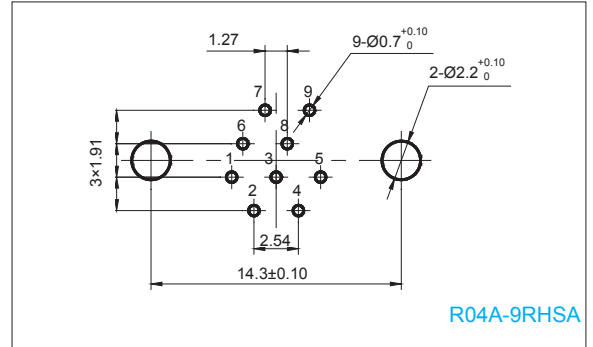

Remark: 1. All dimensions are in mm.
2. View top side from PCB board.

R04A Series Right Angle to PCB Connectors SA Style-PCB Layout

Plug Connectors

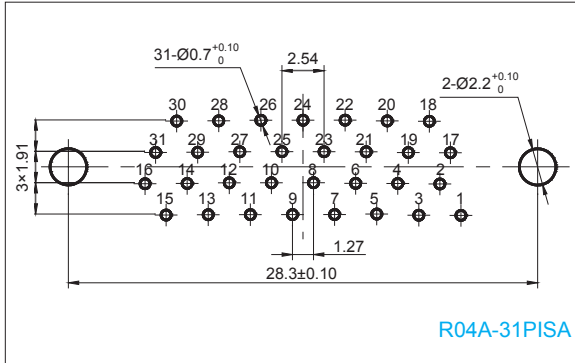

Receptacle Connectors

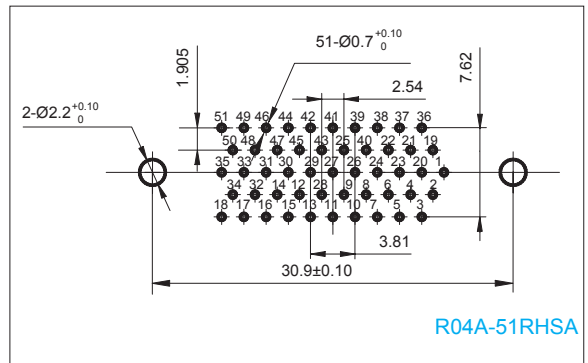
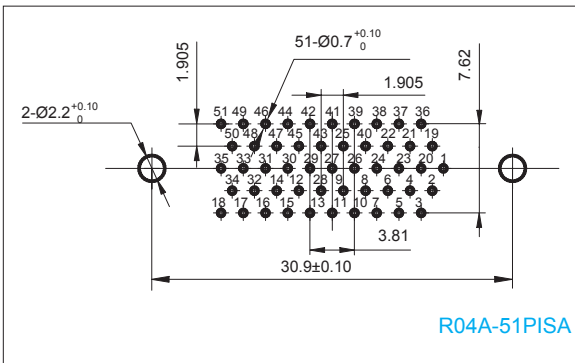
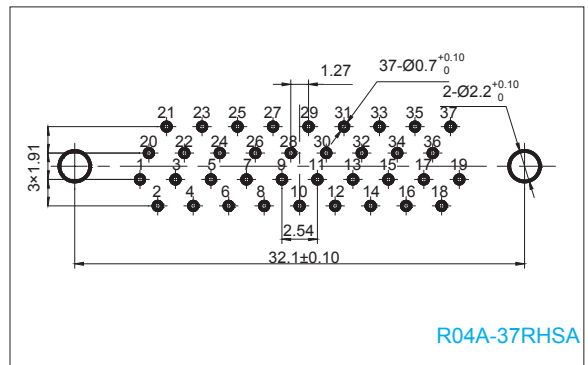
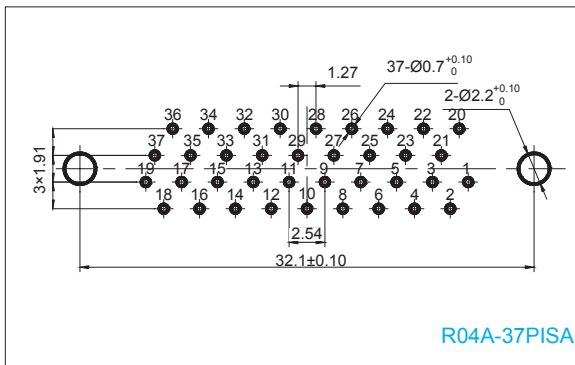
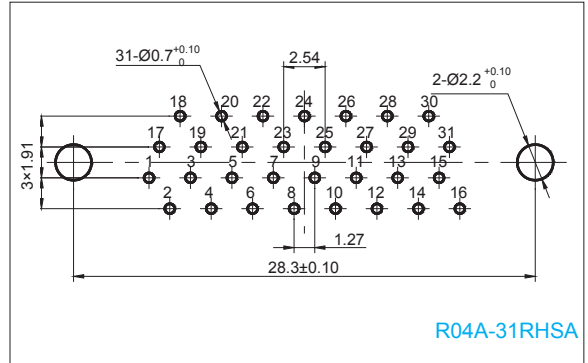

Remark: 1. All dimensions are in mm.
2. View top side from PCB board.

R04A Series Straight To PCB Connectors-SB Style

Product Stereogram



Outline Dimensions

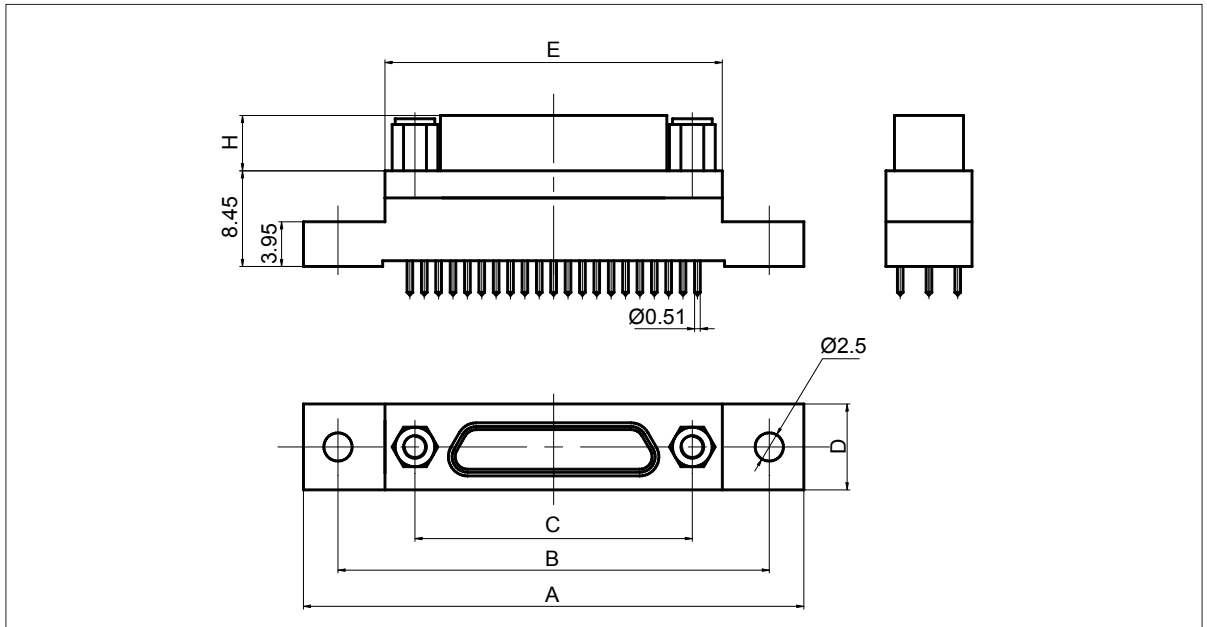

Part Number	Outline Dimensions						
	A	B	C	D	E	H	
						PI	RH
R04A-9PISB	35.31	29.21	14.35	7.9	20.1	4.6	4.9
R04A-15PISB	35.31	29.21	18.16	7.9	23.9	4.6	4.9
R04A-21PISB	42.93	36.83	21.97	7.9	30.0	4.6	4.9
R04A-25PISB	44.2	38.1	24.51	7.9	32.4	4.6	4.9
R04A-31PISB	51.82	45.72	28.32	7.9	40.0	4.6	4.9
R04A-37PISB	59.44	53.34	32.13	7.9	47.6	4.6	4.9
R04A-51PISB	57.64	50.8	30.86	8.9	45.1	4.6	4.9

Remark: All dimensions are in mm.

R04A Series Right Angle to PCB Connectors SB Style-PCB Layout

■ Plug Connectors

■ Receptacle Connectors

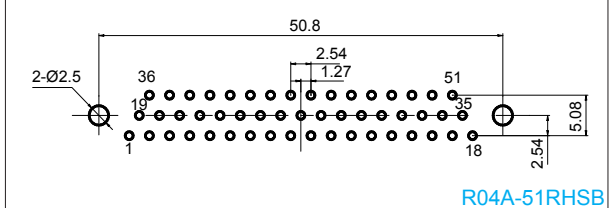
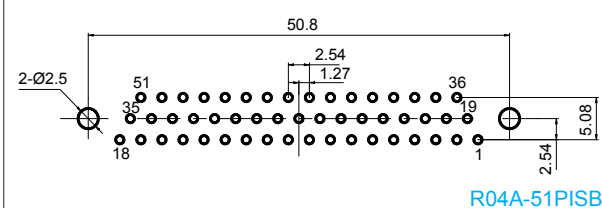
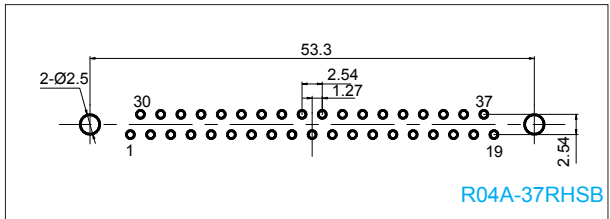
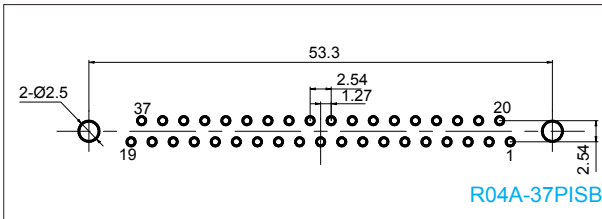
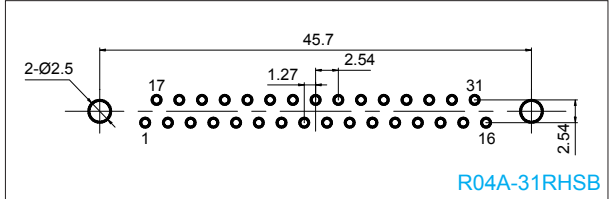
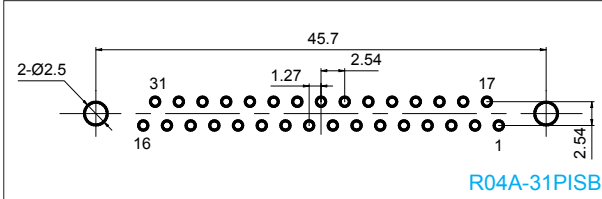
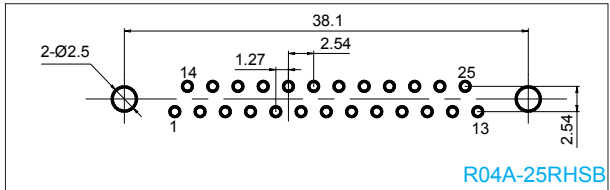
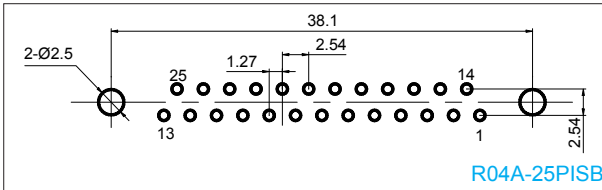
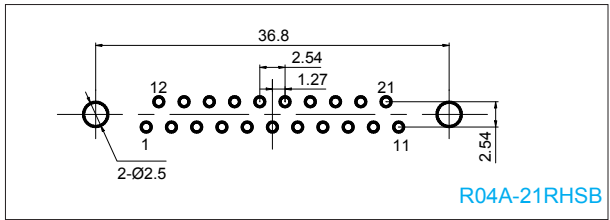
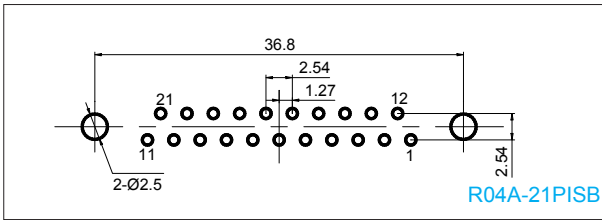
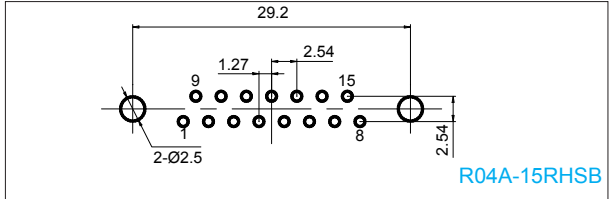
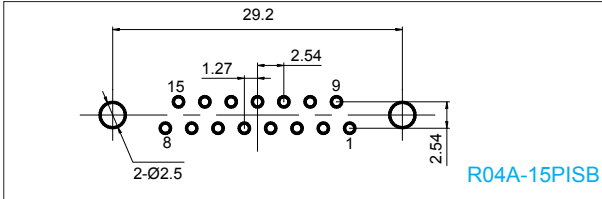
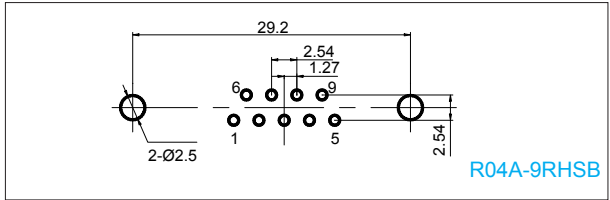
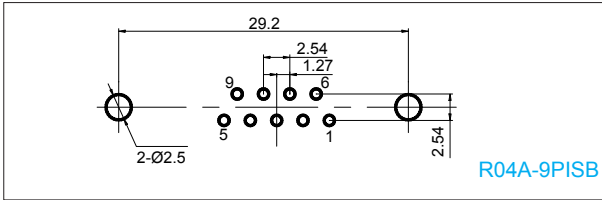

Remark: 1. All dimensions are in mm.
2. View top side from PCB board.

